



INSTRUCTION MANUAL

NPPA-TT-IDC

PATCH PANEL “Easy Patch” | 96 Bantam (TT) Jacks,
IDC Termination



NEUTRIK AG Liechtenstein	NEUTRIK Zürich AG Switzerland	NEUTRIK (UK) Ltd. Great Britain	NEUTRIK USA INC. USA	NEUTRIK Tokyo Ltd. Japan	NEUTRIK France France	NEUTRIK Vertriebs GmbH Germany/Netherlands/Austria
Tel.: +423/237 24 24	Tel.: +41 44/736 5010	Tel.: +44 1983/811 441	Tel.: +1 732/901 9488	Tel.: +81 3/3663 4733	Tel.: +33 1/4131 6750	Tel.: +49 8131/28 08 90
Fax: +423/232 53 93	Fax: +41 44/736 5011	Fax: +44 1983/811 439	Fax: +1 732/901 9608	Fax: +81 3/3663 4796	Fax: +33 1/4131 0511	Fax: +49 8131/28 08-30
www.neutrik.com						

Draft. Nr.: BDA98-1/ 3102M0881
Update: 03.08.2009

NEUTRIK

Data subject to change without prior notice. ©2007 NEUTRIK . ALL RIGHTS RESERVED.



Index

1. Electrical configuration3

2. Grounding variations4

3. Wiring5

4. Cable retention7

5. Channel identification7

6. Replacement9

7. Technical data11

8. Content of supply11

Dimensional Drawings "Easy Patch" NPPA-TT-IDC

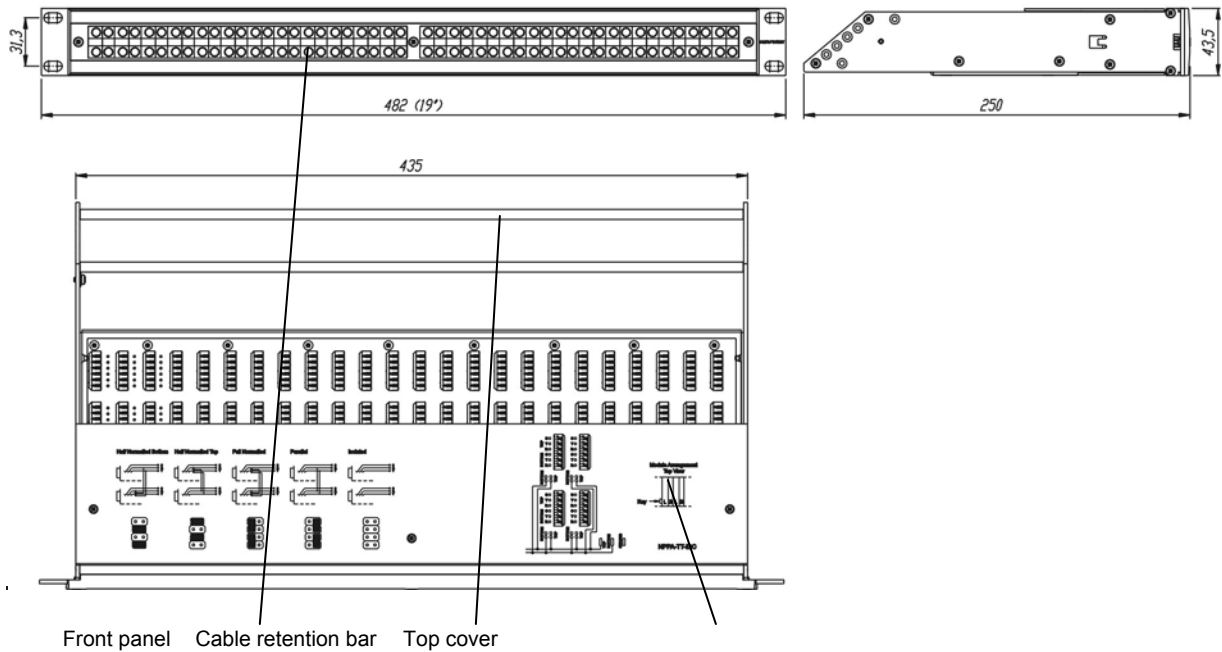



1. Electrical configuration

The Neutrik "Easy Patch" Patch Panel is fitted with high quality, long life NJ3TTA gold plated double contact jacks (2 x 48). This Patch Panel is an innovative and compact patching system (just 1 U high) for 19" rack mounting. Robustly housed in black coated steel shell and featuring precision aluminum fittings it is built to last. The Neutrik "Easy Patch" is suitable for analog and digital audio signals.

The "Easy Patch" is available in five normalling configurations (fully loaded).

- half normalled bottom row
- half normalled top row
- full normalled
- parallel
- isolated

The programming feature allows to set all possible switching configurations very easy with jumpers on the print and individually for each channel.

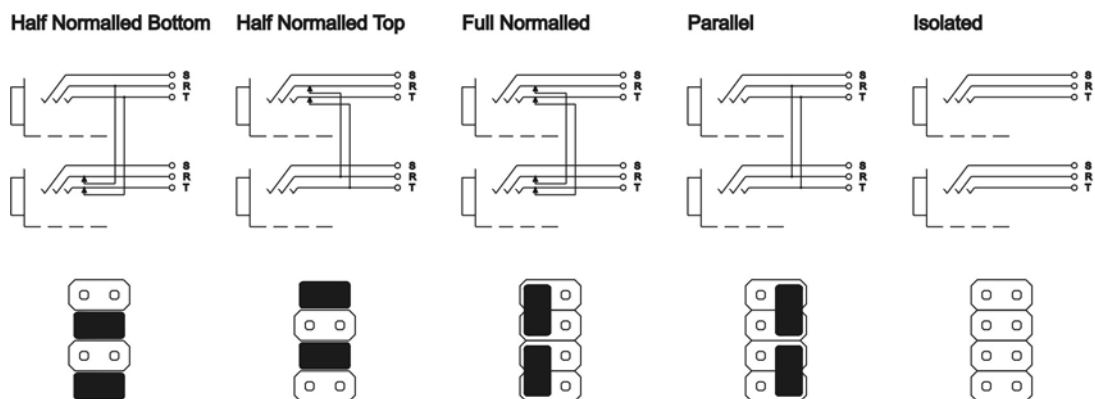

Configuration Chart

The standard configuration of the NPPA-TT-IDC is half normalled bottom row.



2. Grounding variations

The flexible grounding system provides the following versions.

Individual: Each channel ground (“S” terminal) is connected to the dedicated ground conductor (drain wire) of the incoming cable shield, no connection between the solder pads. This is the standard configuration.

Central: All channel grounds (individual Top and Bottom row) are connected via the Top and Bottom PCB bus by connecting the solder pads. The connection between Top and Bottom bus is made by jumpers.

Chassis Common: The same as Central but with jumpers connecting the Top and Bottom row bus to the chassis flat tab which is connected to chassis via ground cable.

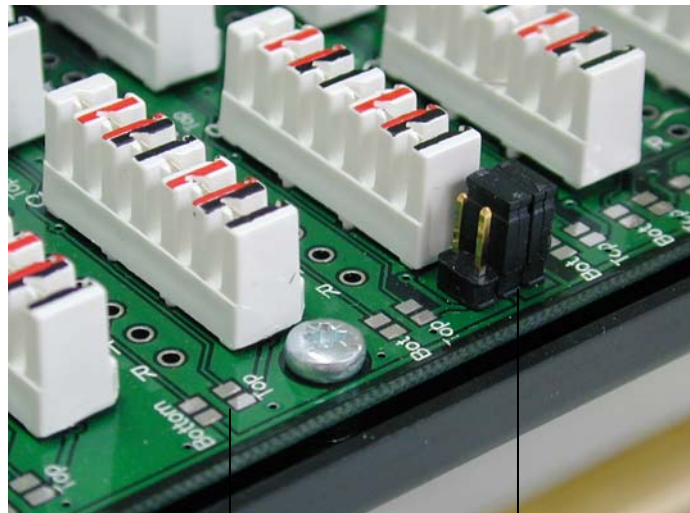
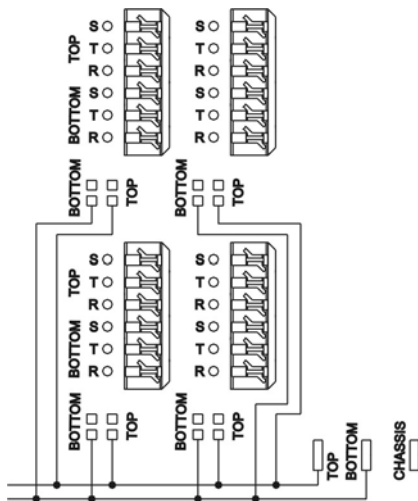

Solder Pats

Jumpers

Symbolic of Jumper configurations

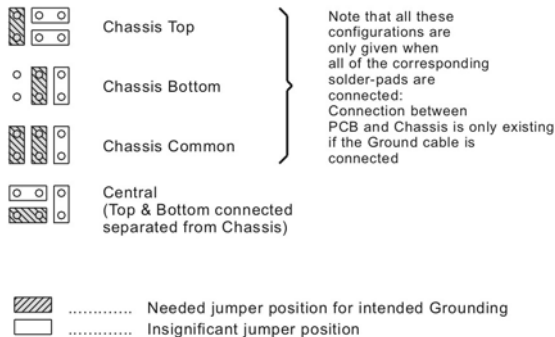

NOTE: In standard configuration there is no ground connection between top and bottom row unless it is provided by an inserted patch cable. If this is required, as in the case of phantom powered microphone lines, make the connection via patch cable or by the normalling feature.



3. Wiring

For access to the terminals remove the top cover with three cross-recessed screws (M2.5x8mm).



IDC-terminals with gas tight connection enable fast and easy wiring. No soldering or fixing with screws is necessary. For wiring please use the original LSA-tool from Krone (Product Nr.: 6417/1/810).



Krone LSA - tool

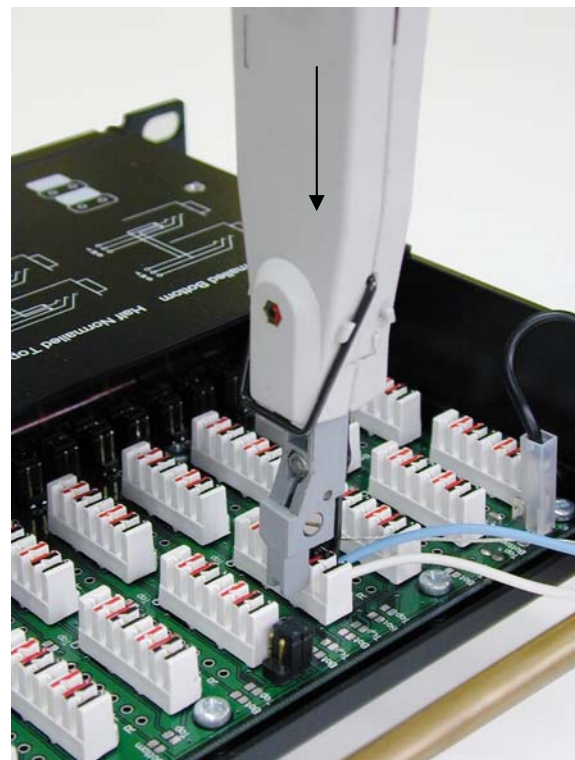

Assembly



Color coding of terminals:

- white - sleeve (shield)
- red - tip (Signal +)
- black - ring (Signal -)

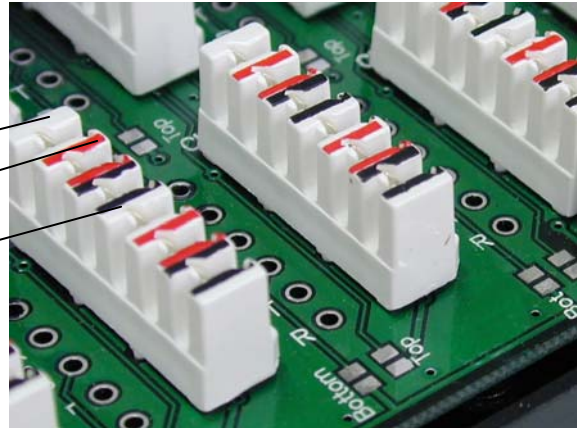

The terminal handles solid cables AWG 26 to 20.

Wire (conductor) diameter	Wires per slot
$\geq 0.40 \text{ mm} \leq 0.65 \text{ mm}$	2
$\geq 0.65 \text{ mm} \leq 0.90 \text{ mm}$	1

When using wire in the range of 0.4 to 0.65mm diameter, the modules allow up to two identical wires of the same diameter to be terminated in one contact. It is not possible to use 2 wires of differing diameter.

Terminations with stranded wire range

No of strands	Diameter of each wire strand	Nominal insulated diameter
7	0.15 mm (AWG 34)	1.10 mm
7	0.20 mm (AWG 32)	1.20 mm



4. Cable retention

The built in cable retention bar is at the back at the casing. Simply attach the cables with cable ties to the bar as shown on the photo.

For large and heavy bundles there is an additional strain relief bar NPPA-S available. It is attached to the casing with four screws.



5. Channel identification

The front panel is equipped with **channel identification strips** located in the center of the channels and marked with the channel numbers 1-24 and 25-48 respectively.

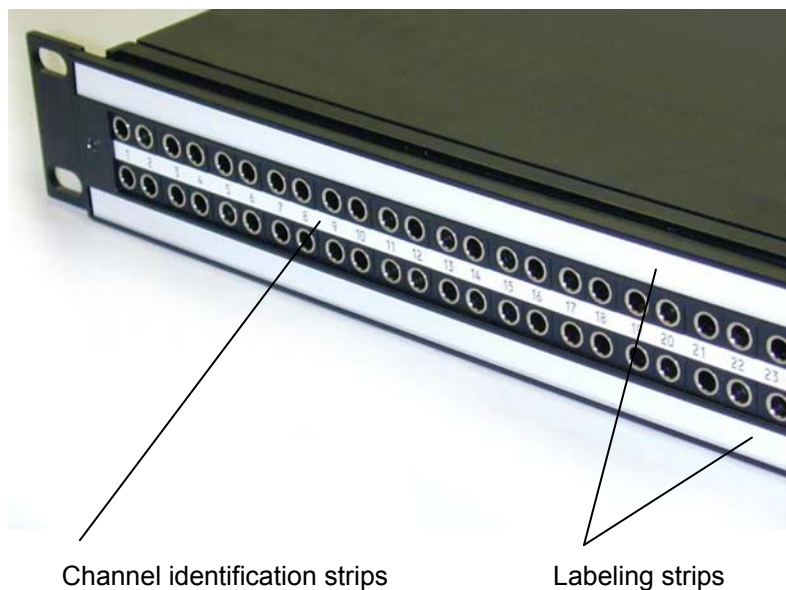

For the perfect management of the system and for individual identification according to customer's needs there are two large and separate labeling strips, one for the bottom and one for the top row.



NPPA-TT-IDC Instruction Manual

To write on the paper you have to unscrew one of the outer fixing screws of the front panel. Then pull out the side-stop, the transparent foil and the paper strip itself.

After marking is done assemble the parts in reversed sequence.

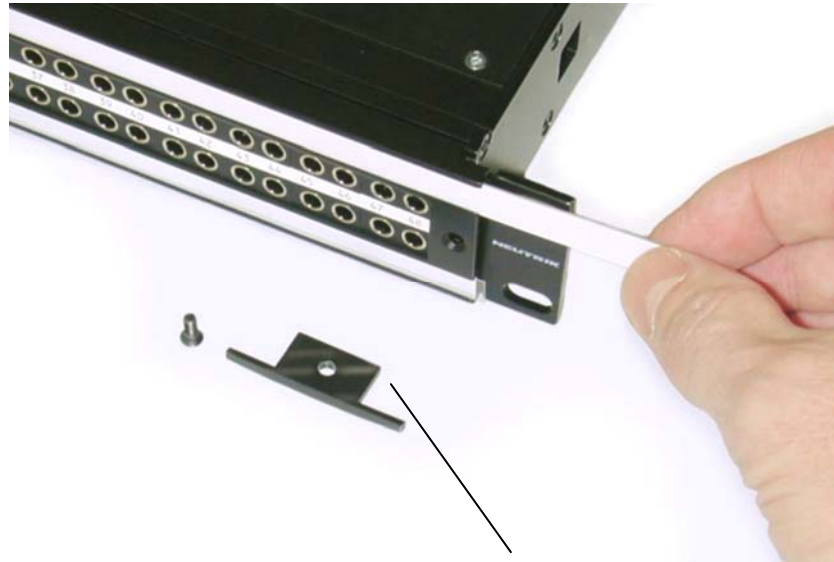

Remove labeling strip

Side Stop

NOTE: For easy and perfect marking you can use our designation software “PatchLabel” which is available on our web site www.neutrik.com free of charge.

Print-Out software “Patch Label”

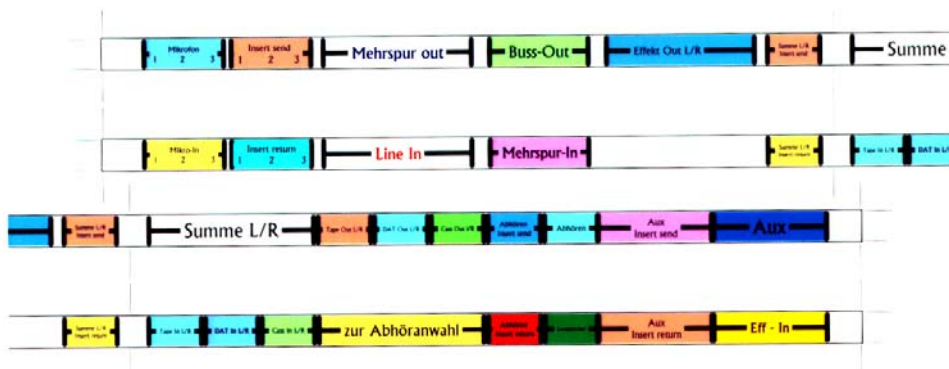



6. Replacement of Jack Pairs

Each individual jack pair can be exchanged quickly and without fuss even while the panel is "on air". For replacement simply remove the easy accessible jack pairs.



Module consisting of 2 Jack Pairs



Remove Front Panel by unscrewing the 3 black cross-recessed screws (M3x8 Taptite), remove the two side-stops.



Push out the channel identification strips.

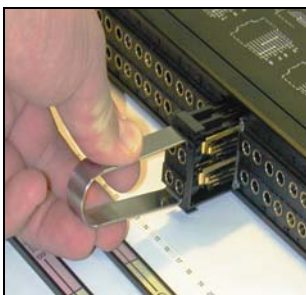

Pull one module out of the casing using the supplied disassembling pliers



NPPA-TT-IDC Instruction Manual

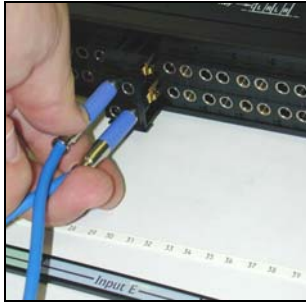

Alternatively the jack pairs may be pulled out by the use of two Bantam plugs (diagonally plugged in).

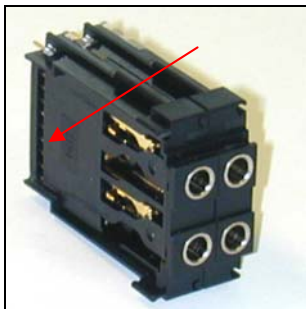

The two jack pairs have to be re-assembled in the right way so that the thicker body marked "left" is put on the left side with the mark outside and readable.

To complete, push the new jack pairs into the casing again with the mark on the left side (If more than one module are removed always assemble from the center to the right or left side and be careful that the keys on the left side of the jack pairs find their guiding slots. If all jack pairs are removed start at the casing support in the center and assemble to the right and left side). Slide in again the channel identification strips (best from the outside inwards) and fix the front panel with the black cross-recessed screws. Don't forget to insert the side-stops before fixing the screws.



7. Technical Data

7.1 Electrical

Frequency range:	DC > 50 MHz
Digital suitability:	Digital audio acc. to AES/EBU
Channel separation:	> 100 dB @ 10 kHz, 600 Ω terminated > 40 dB @ 6 MHz, 110 Ω terminated
Insulation resistance:	> 10 ⁹ Ω @ 500 V dc
Connector contact resistance:	< 20 mΩ
Switch contact resistance:	< 25 mΩ
Dielectric strength:	1000 V dc

7.2 Mechanical

Lifetime:	> 5.000 Insertion / withdrawal cycles
Insertion / Withdrawal force:	< 10 N / > 8 N
Cable retention force:	70 N max per cable retention bar
Dimensions (rack mount):	482 mm (W) × 44 mm (H) (19" × 1 U)
Depth:	250 mm (9.85")
Weight:	2.6 kg
Temperature range:	-30°C to +80°C

7.3 Materials

Jack housing:	PA 66 blend
Jack contacts:	CuSn6 – TRIBOR [®] plated (0.2 μm AuCo over 2 μm NiP)
Casing:	Steel and aluminum, black coated
Front Panel:	AlMgSi 0.5 F22

8. Content of supply

8.1 Standard supply

The compact Neutrik "Easy Patch" NPPA-TT-IDC consists of:

- Black coated steel casing with aluminum fittings
- 2 x 48 highly integrated NEUTRIK NJ3TTA jacks with gold plated double contacts and specially designed normalling mechanism (standard: half normalised bottom row)
- Integrated internal pre-wiring with jumpers on print
- 48 KRONE IDC terminals 6-pole
- Chassis integrated cable retention
- 1 Disassembling pliers
- 1 Instruction Manual

8.2 Replacement

- **NJ3TTA-4-I** blocks of **2** channels; **isolated**; cover identification color: **orange**
- **NKTT0x** **Patch cable** (available in different lengths and colors)